



■ Klinik & Pflege Seite 89

rollgroup®

Unsere Rollen für Klinik und Pflege erfüllen alle Anforderungen an Hygiene, Komfort und Sicherheit.

Sie sind bedienungsfreundlich und gut zu reinigen.





Krankenbetten- rollen

- Durchmesser 125 – 150 mm
- Kunststoffgehäuse aus Polyamid
- Rad AUX

110–150 kg

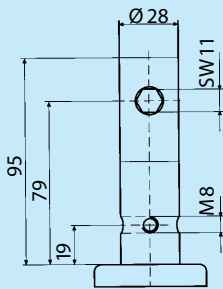

■ Gehäuse







- Kunststoff Polyamid
- Präzisionskugellager abgedichtet
- waschbar
- quer und längs zur Fahrtrichtung verwendbar

■ Rad AUX

- Radkörper aus Polyamid
- Lauffläche aus Polyurethan
- Farbe grau, spurlos
- kontaktverfärbungsfrei
- Präzisionskugellager abgedichtet



Lenkrollen zentral-, total- oder richtungsfeststellbar

Bestell-Code	 mm	 kg	 mm	 mm	 mm	 mm	 mm
27C AUX 125 Z04 S30	125	110	20	28	95	40	158
27C AUX 150 Z04 S30	150	150	20	28	95	52	188







Varianten:



Auch mit Profil D30 (Schaltlocke halbrund) lieferbar.



Lenkrollen zentral-, totalfeststellbar

Bestell-Code	 mm	 kg	 mm	 mm	 mm	 mm	 mm
27Z AUX 125 Z04 S30	125	110	20	28	95	40	158
27Z AUX 150 Z04 S30	150	150	20	28	95	52	188

Varianten:

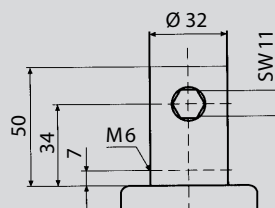

Auch mit Befestigungszapfen Z05 lieferbar.

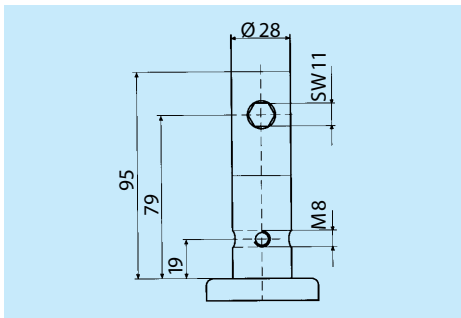

■ Gehäuse

- Kunststoff Polyamid
- Präzisionskugellager abgedichtet
- waschbar

■ Rad SXX

- Radkörper aus Polyamid
- Lauffläche aus Polyurethan
- Farbe grau, spurlos
- kontaktverfärbungsfrei
- Präzisionskugellager abgedichtet
- elektrisch leitfähig



Lenkrollen zentral-, total- oder richtungsfeststellbar

Bestell-Code	mm	kg	mm	mm	mm	mm	mm
27C SXX 125 Z04 S30	125	110	20	28	95	40	158
27C SXX 150 Z04 S30	150	150	20	28	95	52	188

Varianten:



Lenkrollen zentral-, totalfeststellbar

Bestell-Code	mm	kg	mm	mm	mm	mm	mm
27Z SXX 125 Z04 S30	125	110	20	28	95	40	158
27Z SXX 150 Z04 S30	150	150	20	28	95	52	188

Varianten:

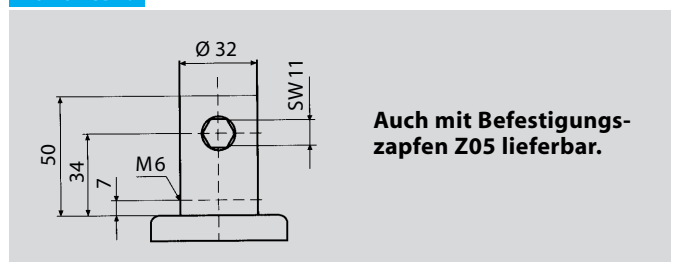



Richtungsfeststellung

Neutral

Totalfeststellung

INFO

Die Rollen der Serie 27Z und 27C sind wartungsfrei!
Voreinstellungen und Nachstellen sind hier nicht erforderlich.



Serie 27Z
mit Totalfeststellung



Einstellung
bei Lieferung



Serie 27C
mit Total- oder
Richtungsfeststellung



Einstellung
bei Lieferung

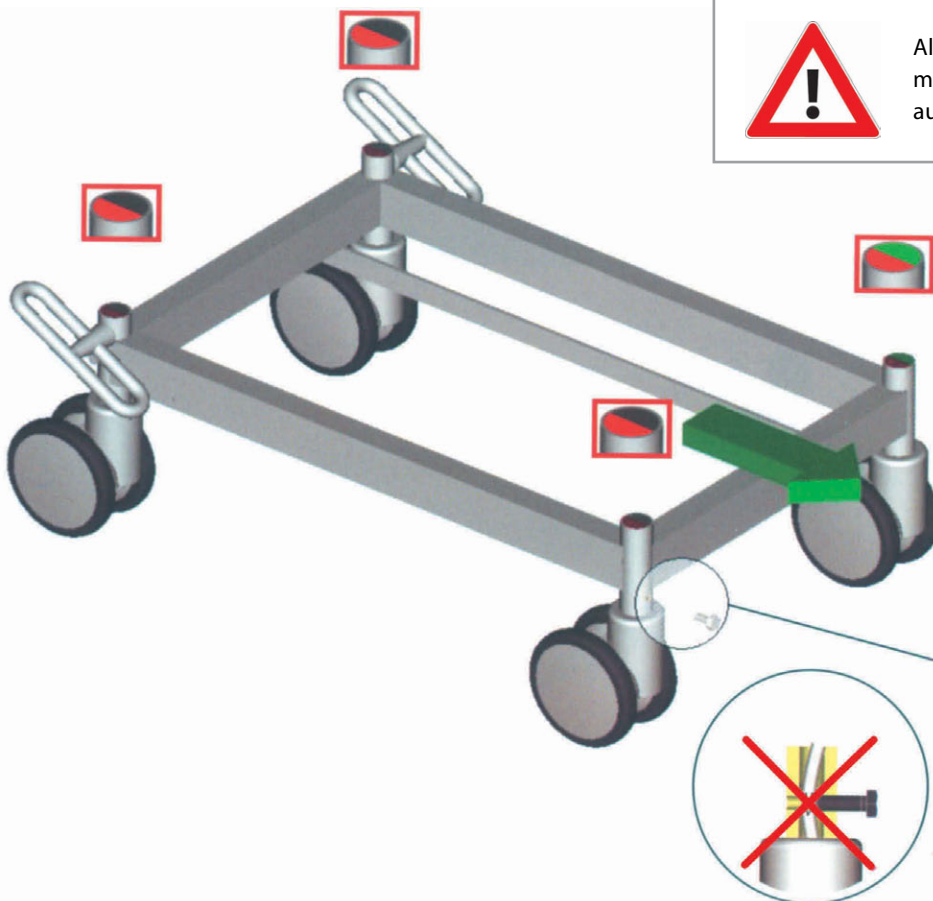
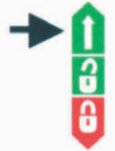

Alle rot gekennzeichneten Teile
müssen zur gleichen Gestellseite
ausgerichtet sein!

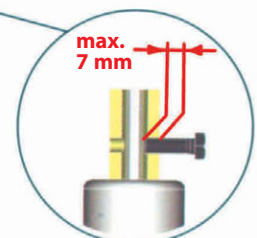

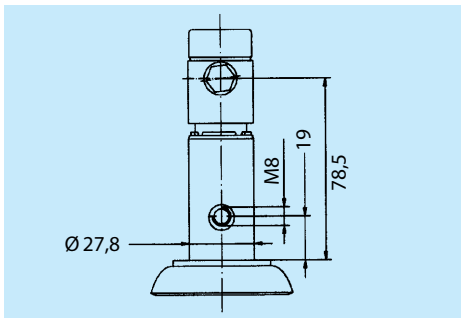

■ Gehäuse







- Stahlblech verzinkt-chromatiert
- Schwenklager mit zweifachem Kugelkranz
- staub- und spritzwassergeschützt

■ Rad JPP

- Radkörper aus Polyurethan
- Lauffläche aus thermoplastischem Gummi
- Farbe grau, spurlos
- Fadenschutz
- Präzisionskugellager



Lenkrollen zentral-, total- oder richtungsfeststellbar

Bestell-Code	 mm	 kg	 mm	 mm	 mm	 mm
23C JPP 125 Z04-28	125	100	32	28	44	158



Lenkrollen zentral-, totalfeststellbar

Bestell-Code	 mm	 kg	 mm	 mm	 mm	 mm
23Z JPP 125 Z04-28	125	100	32	28	44	158

Varianten:

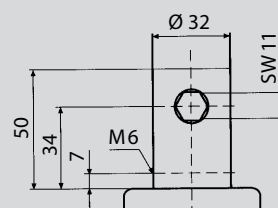

Auch mit Befestigungszapfen Z05 lieferbar.



Krankenbettenrollen

- Durchmesser 125 – 150 mm
- Gehäuse aus Stahlblech verchromt
- Rad JPC

100 – 120 kg

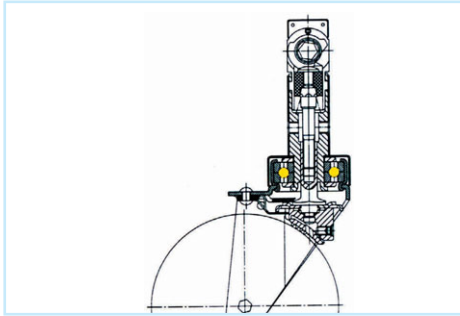

■ Gehäuse







- Stahlblech verchromt
- Präzisionskugellager im Gabelkopf
- waschbar

■ Rad JPC

- Radkörper aus Polyurethan
- Lauffläche aus thermoplastischem Gummi
- Farbe grau, spurlos
- Fadenschutz
- Edelstahlpräzisionskugellager









Lenkrollen zentral-, total- oder richtungsfeststellbar

Bestell-Code	 mm	 kg	 mm	 mm	 mm	 mm	 mm
22C JPC 125 Z04S	125	100	32	28	100	44	164
22C JPC 150 Z04S	150	120	32	28	100	51	191



Lenkrollen zentral-, totalfeststellbar

Bestell-Code	 mm	 kg	 mm	 mm	 mm	 mm	 mm
22Z JPC 125 Z04S	125	100	32	28	100	44	164
22Z JPC 150 Z04S	150	120	32	28	100	51	191

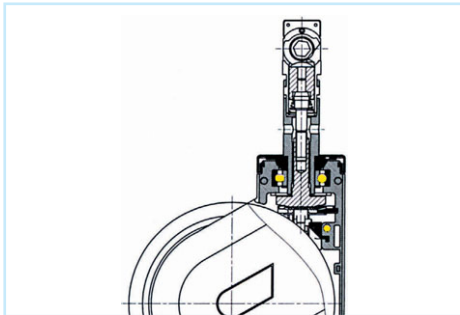

■ Gehäuse

- Kunststoff Polyamid
- abgedichtetes Präzisionskugellager
- waschbar

■ Rad AUX

- Radkörper aus Polyamid
- Lauffläche aus Polyurethan
- Farbe grau, spurlos
- kontaktverfärbungsfrei
- Präzisionskugellager abgedichtet



Lenkrollen zentral-, total- oder richtungsfeststellbar

Bestell-Code	mm	kg	mm	mm	mm	mm	mm
26C AUX 125 Z04 S	125	100	32	28	100	41,2	161
26C AUX 150 Z04 S	150	120	32	28	100	50,0	185



Lenkrollen zentral-, totalfeststellbar

Bestell-Code	mm	kg	mm	mm	mm	mm	mm
26Z AUX 125 Z04 S	125	100	32	28	100	41,2	161
26Z AUX 150 Z04 S	150	120	32	28	100	50,0	185



Krankenbetten- rollen

- Durchmesser 125 – 150 mm
- Kunststoffgehäuse aus Polyamid
- Rad SXX



100 – 120 kg

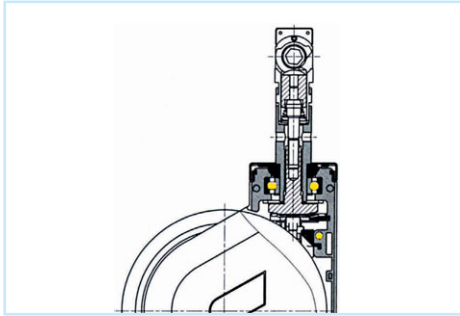

■ Gehäuse







- Kunststoff Polyamid
- Präzisionskugellager abgedichtet
- waschbar

■ Rad SXX

- Radkörper aus Polyamid
- Lauffläche aus Polyurethan
- Farbe grau, spurlos
- kontaktverfärbungsfrei
- Präzisionskugellager abgedichtet
- elektrisch leitfähig









Lenkrollen zentral-, total- oder richtungsfeststellbar

Bestell-Code	 mm	 kg	 mm	 mm	 mm	 mm	 mm
26C SXX 125 Z04 S	125	100	32	28	96	41,2	161
26C SXX 150 Z04 S	150	120	32	28	96	50,0	185



Lenkrollen zentral-, totalfeststellbar

Bestell-Code	 mm	 kg	 mm	 mm	 mm	 mm	 mm
26Z SXX 125 Z04 S	125	100	32	28	96	41,2	161
26Z SXX 150 Z04 S	150	120	32	28	96	50,0	185



Doppeltritthebel

Doppeltritthebel Flache Form mit geriffelter Trittfäche
Ausführung Sechskant- oder Halbrundprofil rechts/links



Doppeltritthebel

Doppeltritthebel Aus Polyamid, Farbe grafitgrau
mit Schraube und Mutter zum Klemmen der Sechskantstange SW11



Schalthebel

Länge in mm

Schalthebel kurz 28,00
Schalthebel lang 63,75



Lagerbuchse

Lagerbuchse

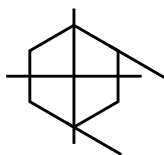

Profilstange SW 11

Länge in mm

Profilstange SW11 1000



**Weitere Produkte und Zubehör für den Reha-Bereich finden Sie
in unserem rollgroup®-Sonderkatalog 'REHA'.**

Fragen Sie uns danach – gerne lassen wir Ihnen den Katalog zukommen!



PRODUKTE UND ZUBEHÖR FÜR DEN REHA-BEREICH

