



APPARATE ROLLEN

Apparaterollen sind leicht und schlank gebaute Rollen mit Stahlblech- oder Kunststoffgehäuse, die vornehmlich im Innenbereich für leichte bis mittelschwere Geräte eingesetzt werden.

Durch ihre Bauweise ermöglichen sie ein Maximum an Beweglichkeit der jeweiligen Geräte und bestechen durch hohe Laufruhe bei geringem Rollwiderstand.

Einsatzgebiete sind zum Beispiel Ladeneinrichtungen, Displays, Betriebseinrichtungen, Gerätebau, Medizintechnik und Pflegebereich.





50 - 100 KG

SERIE **21**

- Durchmesser 50 - 150 mm
- Gehäuse aus Stahlblech
- Thermoplastisches Gummirad

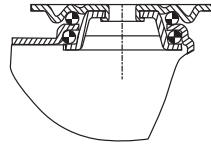

GEHÄUSE

- Stahlblech verzinkt-chromatiert
- Schwenklager mit zweifachem Kugelkranz
- Radachse verschraubt

RAD JPO

- Radkörper aus Polypropylen
- Lauffläche aus thermoplastischem Gummi
- Farbe grau, spurlos
- Gleitlager



LENKROLLE MIT ANSCHRAUBPLATTE

BESTELLCODE	mm	kg	mm	mm	mm	mm	mm	mm
21L JPO 050 P03	50	50	19	60 x 60	48,0 / 38,0 x 48,0 / 38,0	6,3	25	70
21L JPO 075 P03	75	75	25	60 x 60	48,0 / 38,0 x 48,0 / 38,0	6,3	24	100
21L JPO 100 P04	100	100	32	77 x 67	61,5 / 56,0 x 51,5 / 46,5	8,5	37	135
21L JPO 125 P04	125	100	32	77 x 67	61,5 / 56,0 x 51,5 / 46,5	8,5	40	160
21L JPO 125 P05	125	100	32	95 x 70	75,0 x 50,0	11,0	40	160
21L JPO 150 P04	150	100	32	77 x 67	61,5 / 56,0 x 51,5 / 46,5	8,5	44	185



LENKROLLE MIT ANSCHRAUBPLATTE UND TOTALFESTSTELLER

BESTELLCODE	mm	kg	mm	mm	mm	mm	mm	mm
21N JPO 050 P03	50	50	19	60 x 60	48,0 / 38,0 x 48,0 / 38,0	6,3	25	70
21N JPO 075 P03	75	75	25	60 x 60	48,0 / 38,0 x 48,0 / 38,0	6,3	24	100
21N JPO 100 P04	100	100	32	77 x 67	61,5 / 56,0 x 51,5 / 46,5	8,5	44	135
21N JPO 125 P04	125	100	32	77 x 67	61,5 / 56,0 x 51,5 / 46,5	8,5	42	160
21N JPO 125 P05	125	100	32	95 x 70	75,0 x 50,0	11,0	42	160
21N JPO 150 P04	150	100	32	77 x 67	61,5 / 56,0 x 51,5 / 46,5	8,5	41	185



LENKROLLE MIT ANSCHRAUBPLATTE UND RICHTUNGSFESTSTELLER

BESTELLCODE	mm	kg	mm	mm	mm	mm	mm	mm
21I JPO 100 P04	100	100	32	77 x 67	61,5 / 56,0 x 51,5 / 46,5	8,5	44	135
21I JPO 125 P04	125	100	32	77 x 67	61,5 / 56,0 x 51,5 / 46,5	8,5	42	160
21I JPO 150 P04	150	100	32	77 x 67	61,5 / 56,0 x 51,5 / 46,5	8,5	41	185



BOCKROLLE MIT ANSCHRAUBPLATTE

BESTELLCODE	mm	kg	mm	mm	mm	mm	mm	mm
21B JPO 050 P02	50	50	19	55 x 55	44,0 / 38,5 x 44,0 / 38,5	6,3		70
21B JPO 075 P14	75	75	25	67 x 60	48,0 / 40,0 x 48,0 / 40,0	6,3		100
21B JPO 100 P04	100	100	32	77 x 67	61,5 / 56,0 x 51,5 / 46,5	8,5		135
21B JPO 125 P04	125	100	32	77 x 67	61,5 / 56,0 x 51,5 / 46,5	8,5		160
21B JPO 125 P05	125	100	32	95 x 70	75,0 x 50,0	11,0		160
21B JPO 150 P04	150	100	32	77 x 67	61,5 / 56,0 x 51,5 / 46,5	8,5		185

GEHÄUSE

- Stahlblech verzinkt-chromatiert
- Schwenklager mit zweifachem Kugelkranz
- Radachse verschraubt

RAD JPO/JPI

- Radkörper aus Polypropylen
- Lauffläche aus thermoplastischem Gummi
- Farbe grau, spurlos
- Gleitlager
- JPI: Gleitlager zur Montage ohne Distanzrohr

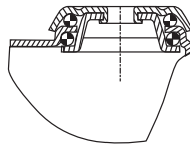

50 - 100 KG







- Durchmesser 50 - 150 mm
- Gehäuse aus Stahlblech
- Thermoplastisches Gummirad

**APPARATE
ROLLEN**

SERIE **21**









LENKROLLE MIT RÜCKENLOCH

BESTELLCODE	 mm	 kg	 mm	 mm	 mm	 mm
21L JPO 050 P01	50	50	19	11	25	70
21L JPO 075 P01	75	75	25	11	24	100
21L JPO 100 P01	100	100	32	11	37	135
21L JPO 125 P01	125	100	32	11	40	160
21L JPO 150 P01	150	100	32	11	44	185







LENKROLLE MIT RÜCKENLOCH UND TOTALFESTSTELLER

BESTELLCODE	 mm	 kg	 mm	 mm	 mm	 mm
21N JPO 050 P01	50	50	19	11	25	70
21N JPO 075 P01	75	75	25	11	24	100
21N JPO 100 P01	100	100	32	11	44	135
21N JPO 125 P01	125	100	32	11	42	160
21N JPO 150 P01	150	100	32	11	41	185







BOCKROLLE MIT RÜCKENLOCH

BESTELLCODE	 mm	 kg	 mm	 mm	 mm
21B JPO 075 P01	75	75	25	11	100
21B JPO 100 P01	100	100	32	11	135
21B JPO 125 P01	125	100	32	11	160



RAD

BESTELLCODE	 mm	 kg	 mm	 mm	 mm
JPI 050 x 19 - 6 - 22	50	50	19	6	22
JPO 050 x 19 - 8 - 22	50	50	19	8	22
JPI 075 x 25 - 6 - 27	75	75	25	6	27
JPO 075 x 25 - 8 - 27	75	75	25	8	27
JPO 100 x 32 - 12 - 35	100	100	32	12	35
JPO 125 x 32 - 12 - 35	125	100	32	12	35
JPO 150 x 32 - 12 - 35	150	100	32	12	35



VARIANTEN: Auch mit Befestigungsschraube (S01) lieferbar.

Bei Rad-Ø 100 - 150 mm auch mit Rückenloch-Ø 13 mm lieferbar!



50 - 75 KG

- Durchmesser 50 - 75 mm
- Gehäuse aus Stahlblech
- Thermoplastisches Gummirad

SERIE 21

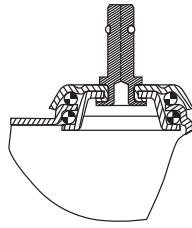

GEHÄUSE

- Stahlblech verzinkt-chromatiert
- Schwenklager mit zweifachem Kugelkranz
- Radachse verschraubt

RAD JPO

- Radkörper aus Polypropylen
- Lauffläche aus thermoplastischem Gummi
- Farbe grau, spurlos
- Gleitlager



LENKROLLE MIT BUNDSTIFT

BESTELLCODE	mm	kg	mm	mm	mm	mm
21L JPO 050 B11 - 11 x 31	50	50	19	11	25	73
21L JPO 075 B11 - 11 x 31	75	75	25	11	24	103



LENKROLLE MIT BUNDSTIFT UND TOTALFESTSTELLER

BESTELLCODE	mm	kg	mm	mm	mm	mm
21N JPO 050 B11 - 11 x 31	50	50	19	11	25	73
21N JPO 075 B11 - 11 x 31	75	75	25	11	24	103



RAD

BESTELLCODE	mm	kg	mm	mm	mm
JPO 050 x 19 - 8 - 22	50	50	19	8	22
JPO 075 x 25 - 8 - 27	75	75	25	8	27

ROHREINSTECKHÜLSE 40KG

VIERKANT [1]

BESTELLCODE	Hülsen- durchmesser in mm	Länge in mm
H01 - 16 x 16	16 x 16	36
H01 - 17 x 17	17 x 17	36
H01 - 18 x 18	18 x 18	36
H01 - 21 x 21	21 x 21	36
H01 - 22 x 22	22 x 22	36
H01 - 23 x 23	23 x 23	36
H01 - 26 x 26	26 x 26	36

RUND [2]

BESTELLCODE	Hülsen- durchmesser in mm	Länge in mm
H02 - 14	14	36
H02 - 15	15	36
H02 - 16	16	36
H02 - 17	17	36
H02 - 18	18	36
H02 - 19	19	36
H02 - 20	20	36
H02 - 22	22	36
H02 - 23	23	36

FÜR HOLZMÖBEL, RUND [3]

BESTELLCODE	Hülsen- durchmesser in mm	Länge in mm
H03 - 15	15	36

[1] [2] [3]



VARIANTEN: Auch mit Radtypen GYO (elektrisch leitfähig, spurlos) sowie mit JPP oder GYP (Präzisionskugellager) lieferbar

GEHÄUSE

- Stahlblech verzinkt-chromatiert
- Schwenklager mit zweifachem Kugelkranz
- Radachse verschraubt

RAD JPO

- Radkörper aus Polypropylen
- Lauffläche aus thermoplastischem Gummi
- Farbe grau, spurlos
- Gleitlager

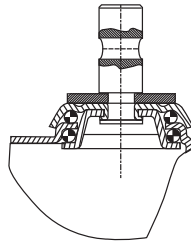

50 - 100 KG





- Durchmesser 50 - 150 mm
- Gehäuse aus Stahlblech
- Thermoplastisches Gummirad

**APPARATE
ROLLEN**

SERIE **21**







LENKROLLE MIT ZAPFENBEFESTIGUNG

BESTELLCODE	 mm	 kg	 mm	 mm	 mm
21L JPO 050 Z01	50	50	19	25	73
21L JPO 075 Z01	75	75	25	24	103
21L JPO 100 Z01	100	100	32	37	138
21L JPO 125 Z01	125	100	32	40	163
21L JPO 150 Z01	150	100	32	44	188







LENKROLLE MIT ZAPFENBEFESTIGUNG UND TOTALFESTSTELLER

BESTELLCODE	 mm	 kg	 mm	 mm	 mm
21N JPO 050 Z01	50	50	19	25	73
21N JPO 075 Z01	75	75	25	24	103
21N JPO 100 Z01	100	100	32	44	138
21N JPO 125 Z01	125	100	32	42	163
21N JPO 150 Z01	150	100	32	41	188



LENKROLLE MIT ZAPFENBEFESTIGUNG UND RICHTUNGSFESTSTELLER

BESTELLCODE	 mm	 kg	 mm	 mm	 mm
21I JPO 100 Z01	100	100	32	44	138
21I JPO 125 Z01	125	100	32	42	163
21I JPO 150 Z01	150	100	32	41	188

HINWEIS: bei Bestellung bitte immer **Zapfendurchmesser** angeben!

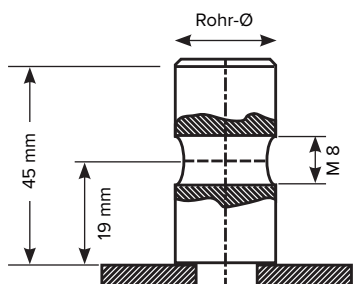

Befestigungszapfen Z01 lieferbar von 18 – 28 mm
(Beschreibung siehe S. 25) sowie Sondermaße auf Anfrage.

Adapterhülse H04 (vierkant) und H05 (rund) ebenfalls erhältlich
(Beschreibung siehe S. 25).



50 - 100 KG

- Durchmesser 50 - 150 mm
- Gehäuse aus Stahlblech
- Thermoplastisches Gummirad

SERIE 21

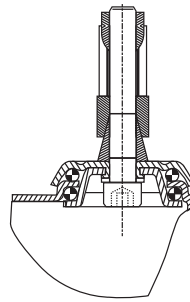

GEHÄUSE

- Stahlblech verzinkt-chromatiert
- Schwenklager mit zweifachem Kugelkranz
- Radachse verschraubt

RAD JPO

- Radkörper aus Polypropylen
- Lauffläche aus thermoplastischem Gummi
- Farbe grau, spurlos
- Gleitlager

EXPANDERBEFESTIGUNG RUND



BESTELLCODE	Rohr-Innen- durchmesser in mm	BESTELLCODE	Rohr-Innen- durchmesser in mm
Z06 - 18,0 - 20,0	18,0 - 20,0	Z06 - 24,0 - 27,0	24,0 - 27,0
Z06 - 19,0 - 21,5	19,0 - 21,5	Z06 - 27,0 - 30,0	27,0 - 30,0
Z06 - 21,5 - 24,0	21,5 - 24,0	Z06 - 31,0 - 35,0	31,0 - 35,0

BITTE BEACHTEN: Bei Bestellungen bitte immer das **Rohr-Innenmaß** angeben!

LENKROLLE MIT EXPANDERBEFESTIGUNG RUND



BESTELLCODE	mm	kg	mm	mm	mm
21L JPO 050 Z06	50	50	19	25	73
21L JPO 075 Z06	75	75	25	24	103
21L JPO 100 Z06	100	100	32	37	138
21L JPO 125 Z06	125	100	32	40	163
21L JPO 150 Z06	150	100	32	44	188

LENKROLLE MIT EXPANDERBEFESTIGUNG RUND UND TOTALFESTSTELLER



BESTELLCODE	mm	kg	mm	mm	mm
21N JPO 050 Z06	50	50	19	25	73
21N JPO 075 Z06	75	75	25	24	103
21N JPO 100 Z06	100	100	32	44	138
21N JPO 125 Z06	125	100	32	42	163
21N JPO 150 Z06	150	100	32	41	188

GEHÄUSE

- Stahlblech verzinkt-chromatiert
- Schwenklager mit zweifachem Kugelkranz
- Radachse verschraubt

RAD JPO

- Radkörper aus Polypropylen
- Lauffläche aus thermoplastischem Gummi
- Farbe grau, spurlos
- Gleitlager

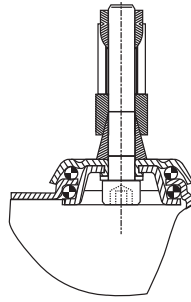

50 - 100 KG

- Durchmesser 50 - 150 mm
- Gehäuse aus Stahlblech
- Thermoplastisches Gummirad

**APPARATE
ROLLEN**

SERIE **21**

EXPANDERBEFESTIGUNG VIERKANT







BESTELLCODE	Rohr-Innen- durchmesser in mm
Z07 - 18,0 - 20,0	18,0 - 20,0
Z07 - 21,5 - 24,0	21,5 - 24,0
Z07 - 24,0 - 27,0	24,0 - 27,0

BESTELLCODE	Rohr-Innen- durchmesser in mm
Z07 - 27,0 - 30,0	27,0 - 30,0
Z07 - 32,0 - 35,0	32,0 - 35,0
Z07 - 36,0 - 40,0	36,0 - 40,0

BITTE BEACHTEN: Bei Bestellungen bitte immer das **Rohr-Innenmaß** angeben!





LENKROLLE MIT EXPANDERBEFESTIGUNG VIERKANT



BESTELLCODE	 mm	 kg	 mm	 mm	 mm
21L JPO 050 Z07	50	50	19	25	73
21L JPO 075 Z07	75	75	25	24	103
21L JPO 100 Z07	100	100	32	37	138
21L JPO 125 Z07	125	100	32	40	163
21L JPO 150 Z07	150	100	32	44	188

LENKROLLE MIT EXPANDERBEFESTIGUNG VIERKANT UND TOTALFESTSTELLER



BESTELLCODE	 mm	 kg	 mm	 mm	 mm
21N JPO 050 Z07	50	50	19	25	73
21N JPO 075 Z07	75	75	25	24	103
21N JPO 100 Z07	100	100	32	44	138
21N JPO 125 Z07	125	100	32	42	163
21N JPO 150 Z07	150	100	32	41	188



50 - 100 KG

SERIE 21

- Durchmesser 50 - 150 mm
- Gehäuse aus Stahlblech
- Thermoplastisches Gummirad

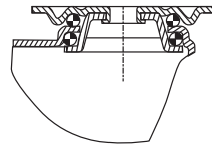

GEHÄUSE

- Stahlblech verzinkt-chromatiert
- Schwenklager mit zweifachem Kugelkranz
- Radachse verschraubt

RAD JPP

- Radkörper aus Polypropylen
- Lauffläche aus thermoplastischem Gummi
- Farbe grau, spurlos
- Fadenschutz
- Präzisionskugellager



LENKROLLE MIT ANSCHRAUBPLATTE

BESTELLCODE	mm	kg	mm	mm	mm	mm	mm	mm
21L JPP 050 P03	50	50	19	60 x 60	48,0 / 38,0 x 48,0 / 38,0	6,3	25	70
21L JPP 075 P03	75	75	25	60 x 60	48,0 / 38,0 x 48,0 / 38,0	6,3	24	100
21L JPP 100 P04	100	100	32	77 x 67	61,5 / 56,0 x 51,5 / 46,5	8,5	37	135
21L JPP 125 P04	125	100	32	77 x 67	61,5 / 56,0 x 51,5 / 46,5	8,5	40	160
21L JPP 125 P05	125	100	32	95 x 70	75,0 x 50,0	11,0	40	160
21L JPP 150 P04	150	100	32	77 x 67	61,5 / 56,0 x 51,5 / 46,5	8,5	44	185



LENKROLLE MIT ANSCHRAUBPLATTE UND TOTALFESTSTELLER

BESTELLCODE	mm	kg	mm	mm	mm	mm	mm	mm
21N JPP 050 P03	50	50	19	60 x 60	48,0 / 38,0 x 48,0 / 38,0	6,3	25	70
21N JPP 075 P03	75	75	25	60 x 60	48,0 / 38,0 x 48,0 / 38,0	6,3	24	100
21N JPP 100 P04	100	100	32	77 x 67	61,5 / 56,0 x 51,5 / 46,5	8,5	44	135
21N JPP 125 P04	125	100	32	77 x 67	61,5 / 56,0 x 51,5 / 46,5	8,5	42	160
21N JPP 125 P05	125	100	32	95 x 70	75,0 x 50,0	11,0	42	160
21N JPP 150 P04	150	100	32	77 x 67	61,5 / 56,0 x 51,5 / 46,5	8,5	41	185



LENKROLLE MIT ANSCHRAUBPLATTE UND RICHTUNGSFESTSTELLER

BESTELLCODE	mm	kg	mm	mm	mm	mm	mm	mm
21I JPP 100 P04	100	100	32	77 x 67	61,5 / 56,0 x 51,5 / 46,5	8,5	44	135
21I JPP 125 P04	125	100	32	77 x 67	61,5 / 56,0 x 51,5 / 46,5	8,5	42	160
21I JPP 150 P04	150	100	32	77 x 67	61,5 / 56,0 x 51,5 / 46,5	8,5	41	185



BOCKROLLE MIT ANSCHRAUBPLATTE

BESTELLCODE	mm	kg	mm	mm	mm	mm	mm	mm
21B JPP 050 P02	50	50	19	55 x 55	44,0 / 38,5 x 44,0 / 38,5	6,3		70
21B JPP 075 P14	75	75	25	67 x 60	48,0 / 40,0 x 48,0 / 40,0	6,3		100
21B JPP 100 P04	100	100	32	77 x 67	61,5 / 56,0 x 51,5 / 46,5	8,5		135
21B JPP 125 P04	125	100	32	77 x 67	61,5 / 56,0 x 51,5 / 46,5	8,5		160
21B JPP 125 P05	125	100	32	95 x 70	75,0 x 50,0	11,0		160
21B JPP 150 P04	150	100	32	77 x 67	61,5 / 56,0 x 51,5 / 46,5	8,5		185



VARIANTEN: Elektrisch leitfähige Version siehe S. 28

GEHÄUSE

- Stahlblech verzinkt-chromatiert
- Schwenklager mit zweifachem Kugelkranz
- Radachse verschraubt

RAD JPP

- Radkörper aus Polypropylen
- Lauffläche aus thermoplastischem Gummi
- Farbe grau, spurlos
- Fadenschutz
- Präzisionskugellager

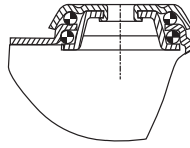

50 - 100 KG







- Durchmesser 50 - 150 mm
- Gehäuse aus Stahlblech
- Thermoplastisches Gummirad

**APPARATE
ROLLEN**

SERIE **21**









LENKROLLE MIT RÜCKENLOCH

BESTELLCODE	 mm	 kg	 mm	 mm	 mm	 mm
21L JPP 050 P01	50	50	19	11	25	70
21L JPP 075 P01	75	75	25	11	24	100
21L JPP 100 P01	100	100	32	11	37	135
21L JPP 125 P01	125	100	32	11	40	160
21L JPP 150 P01	150	100	32	11	44	185







LENKROLLE MIT RÜCKENLOCH UND TOTALFESTSTELLER





BESTELLCODE	 mm	 kg	 mm	 mm	 mm	 mm
21N JPP 050 P01	50	50	19	11	25	70
21N JPP 075 P01	75	75	25	11	24	100
21N JPP 100 P01	100	100	32	11	44	135
21N JPP 125 P01	125	100	32	11	42	160
21N JPP 150 P01	150	100	32	11	41	185



BOCKROLLE MIT RÜCKENLOCH

BESTELLCODE	 mm	 kg	 mm	 mm	 mm
21B JPP 075 P01	75	75	25	11	100
21B JPP 100 P01	100	100	32	11	135
21B JPP 125 P01	125	100	32	11	160

RAD

BESTELLCODE	 mm	 kg	 mm	 mm	 mm
JPP 050 x 19 - 6 - 22	50	50	19	6	22
JPP 075 x 25 - 6 - 28	75	75	25	6	28
JPP 100 x 32 - 8 - 36	100	100	32	8	36
JPP 125 x 32 - 8 - 36	125	100	32	8	36
JPP 150 x 32 - 8 - 36	150	100	32	8	36
JPP 200 x 32 - 8 - 36	200	100	32	8	36



VARIANTEN: Auch mit Befestigungsschraube (S01) lieferbar.

Bei Rad-Ø 100 - 150 mm auch mit Rückenloch-Ø 13 mm lieferbar.



50 - 100 KG

SERIE 21

- Durchmesser 50 - 150 mm
- Gehäuse aus Stahlblech
- Thermoplastisches Gummirad

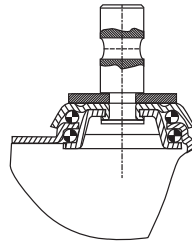

GEHÄUSE

- Stahlblech verzinkt-chromatiert
- Schwenklager mit zweifachem Kugelkranz
- Radachse verschraubt

RAD JPP

- Radkörper aus Polypropylen
- Lauffläche aus thermoplastischem Gummi
- Farbe grau, spurlos
- Fadenschutz
- Präzisionskugellager



LENKROLLE MIT ZAPFENBEFESTIGUNG

BESTELLCODE	mm	kg	mm	mm	mm
21L JPP 050 Z01	50	50	19	25	73
21L JPP 075 Z01	75	75	25	24	103
21L JPP 100 Z01	100	100	32	37	138
21L JPP 125 Z01	125	100	32	40	163
21L JPP 150 Z01	150	100	32	44	188



LENKROLLE MIT ZAPFENBEFESTIGUNG UND TOTALFESTSTELLER

BESTELLCODE	mm	kg	mm	mm	mm
21N JPP 050 Z01	50	50	19	25	73
21N JPP 075 Z01	75	75	25	24	103
21N JPP 100 Z01	100	100	32	44	138
21N JPP 125 Z01	125	100	32	42	163
21N JPP 150 Z01	150	100	32	41	188



LENKROLLE MIT ZAPFENBEFESTIGUNG UND RICHTUNGSFESTSTELLER

BESTELLCODE	mm	kg	mm	mm	mm
21I JPP 100 Z01	100	100	32	44	138
21I JPP 125 Z01	125	100	32	42	163
21I JPP 150 Z01	150	100	32	41	188

HINWEIS: bei Bestellung bitte immer Zapfendurchmesser angeben!

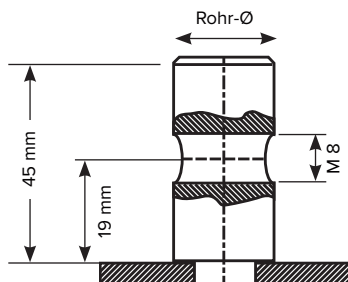

Befestigungszapfen Z01 lieferbar von 18 – 28 mm (Beschreibung siehe S.25) Sondermaße auf Anfrage.

Adapterhülse H04 (vierkant) und H05 (rund) ebenfalls erhältlich (Beschreibung siehe S. 25).

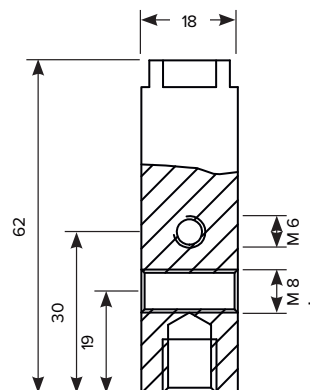

- Adapter-Reduzierhülsen für Rohrbefestigungen
- Befestigungszapfen

ADAPTERHÜLSE VIERKANT 

BESTELLCODE	für Rohr-Innen- durchmesser in mm	für Zapfenmaß (Ø) in mm
H04 - 22,5 - 18	22,5 x 22,5	18
H04 - 27,5 - 18	27,5 x 27,5	18
H04 - 27,0 - 22	27,0 x 27,0	22
H04 - 32,0 - 22	32,0 x 32,0	22
H04 - 36,0 - 22	36,0 x 36,0	22
H04 - 32,0 - 28	32,0 x 32,0	28
H04 - 33,6 - 28	33,6 x 33,6	28
H04 - 36,0 - 28	36,0 x 36,0	28

ADAPTERHÜLSE RUND 

BESTELLCODE	für Rohr-Innen- durchmesser in mm	für Zapfenmaß (Ø) in mm
H05 - 22,0 - 18	22,0	18
H05 - 22,5 - 18	22,5	18
H05 - 28,0 - 22	28,0	22
H05 - 30,0 - 18	30,0	18
H05 - 30,0 - 22	30,0	22

BEFESTIGUNGSZAPFEN RUND 

BESTELLCODE	für Rohr-Innen- durchmesser in mm	Zapfenlänge in mm
Z01 - 18 x 45	18	45
Z01 - 19 x 45	19	45
Z01 - 20 x 45	20	45
Z01 - 21 x 45	21	45
Z01 - 22 x 45	22	45
Z01 - 23 x 45	23	45
Z01 - 25 x 45	25	45
Z01 - 26 x 45	26	45
Z01 - 27 x 45	27	45
Z01 - 28 x 45	28	45
Z01 - 18 x 62 / M6 + M8	18	62





50 - 100 KG

- Durchmesser 50 - 150 mm
- Gehäuse aus Stahlblech
- Thermoplastisches Gummirad

SERIE 21

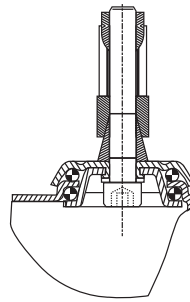

GEHÄUSE

- Stahlblech verzinkt-chromatiert
- Schwenklager mit zweifachem Kugelkranz
- Radachse verschraubt

RAD JPP

- Radkörper aus Polypropylen
- Lauffläche aus thermoplastischem Gummi
- Farbe grau, spurlos
- Fadenschutz
- Präzisionskugellager

EXPANDERBEFESTIGUNG RUND



BESTELLCODE	Rohr-Innen- durchmesser in mm	BESTELLCODE	Rohr-Innen- durchmesser in mm
Z06 - 18,0 - 20,0	18,0 - 20,0	Z06 - 24,0 - 27,0	24,0 - 27,0
Z06 - 19,0 - 21,5	19,0 - 21,5	Z06 - 27,0 - 30,0	27,0 - 30,0
Z06 - 21,5 - 24,0	21,5 - 24,0	Z06 - 31,0 - 35,0	31,0 - 35,0

BITTE BEACHTEN: Bei Bestellungen bitte immer das **Rohr-Innenmaß** angeben!



LENKROLLE MIT EXPANDERBEFESTIGUNG RUND

BESTELLCODE	mm	kg	mm	mm	mm
21L JPP 050 Z06	50	50	19	25	73
21L JPP 075 Z06	75	75	25	24	103
21L JPP 100 Z06	100	100	32	37	138
21L JPP 125 Z06	125	100	32	40	163
21L JPP 150 Z06	150	100	32	44	188



LENKROLLE MIT EXPANDERBEFESTIGUNG RUND UND TOTALFESTSTELLER

BESTELLCODE	mm	kg	mm	mm	mm
21N JPP 050 Z06	50	50	19	25	73
21N JPP 075 Z06	75	75	25	24	103
21N JPP 100 Z06	100	100	32	44	138
21N JPP 125 Z06	125	100	32	42	163
21N JPP 150 Z06	150	100	32	41	188

GEHÄUSE

- Stahlblech verzinkt-chromatiert
- Schwenklager mit zweifachem Kugelkranz
- Radachse verschraubt

RAD JPP

- Radkörper aus Polypropylen
- Lauffläche aus thermoplastischem Gummi
- Farbe grau, spurlos
- Fadenschutz
- Präzisionskugellager

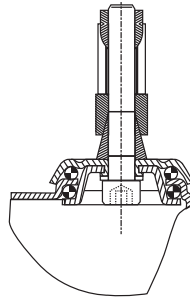

50 - 100 KG

- Durchmesser 50 - 150 mm
- Gehäuse aus Stahlblech
- Thermoplastisches Gummirad

**APPARATE
ROLLEN**

SERIE **21**

EXPANDERBEFESTIGUNG VIERKANT







BESTELLCODE	Rohr-Innen- durchmesser in mm
Z07 - 18,0 - 20,0	18,0 - 20,0
Z07 - 21,5 - 24,0	21,5 - 24,0
Z07 - 24,0 - 27,0	24,0 - 27,0

BESTELLCODE	Rohr-Innen- durchmesser in mm
Z07 - 27,0 - 30,0	27,0 - 30,0
Z07 - 32,0 - 35,0	32,0 - 35,0
Z07 - 36,0 - 40,0	36,0 - 40,0

BITTE BEACHTEN: Bei Bestellungen bitte immer das **Rohr-Innenmaß** angeben!





LENKROLLE MIT EXPANDERBEFESTIGUNG VIERKANT



BESTELLCODE	 mm	 kg	 mm	 mm	 mm
21L JPP 050 Z07	50	50	19	25	73
21L JPP 075 Z07	75	75	25	24	103
21L JPP 100 Z07	100	100	32	37	138
21L JPP 125 Z07	125	100	32	40	163
21L JPP 150 Z07	150	100	32	44	188

LENKROLLE MIT EXPANDERBEFESTIGUNG VIERKANT UND TOTALFESTSTELLER



BESTELLCODE	 mm	 kg	 mm	 mm	 mm
21N JPP 050 Z07	50	50	19	25	73
21N JPP 075 Z07	75	75	25	24	103
21N JPP 100 Z07	100	100	32	44	138
21N JPP 125 Z07	125	100	32	42	163
21N JPP 150 Z07	150	100	32	41	188



50 - 100 KG

- Durchmesser 50 - 150 mm
- Gehäuse aus Stahlblech
- Thermoplastisches Gummirad
- elektrisch leitfähig

SERIE **21**

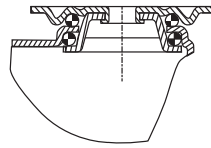

GEHÄUSE

- Stahlblech verzinkt-chromatiert
- Schwenklager mit zweifachem Kugelkranz
- Radachse verschraubt

RAD GYP

- Radkörper aus Polypropylen
- Lauffläche aus thermoplastischem Gummi, elektrisch leitfähig
- Farbe grau, spurlos
- Fadenschutz
- Präzisionskugellager



LENKROLLE MIT ANSCHRAUBPLATTE

BESTELLCODE	mm	kg	mm	mm	mm	mm	mm	mm
21L GYP 050 P03	50	50	19	60 x 60	48,0 / 38,0 x 48,0 / 38,0	6,3	25	70
21L GYP 075 P03	75	75	25	60 x 60	48,0 / 38,0 x 48,0 / 38,0	6,3	24	100
21L GYP 100 P04	100	100	32	77 x 67	61,5 / 56,0 x 51,5 / 46,5	8,5	37	135
21L GYP 125 P04	125	100	32	77 x 67	61,5 / 56,0 x 51,5 / 46,5	8,5	40	160
21L GYP 125 P05	125	100	32	95 x 70	75,0 x 50,0	11,0	40	160
21L GYP 150 P04	150	100	32	77 x 67	61,5 / 56,0 x 51,5 / 46,5	8,5	44	185



LENKROLLE MIT ANSCHRAUBPLATTE UND TOTALFESTSTELLER

BESTELLCODE	mm	kg	mm	mm	mm	mm	mm	mm
21N GYP 050 P03	50	50	19	60 x 60	48,0 / 38,0 x 48,0 / 38,0	6,3	25	70
21N GYP 075 P03	75	75	25	60 x 60	48,0 / 38,0 x 48,0 / 38,0	6,3	24	100
21N GYP 100 P04	100	100	32	77 x 67	61,5 / 56,0 x 51,5 / 46,5	8,5	44	135
21N GYP 125 P04	125	100	32	77 x 67	61,5 / 56,0 x 51,5 / 46,5	8,5	42	160
21N GYP 125 P05	125	100	32	95 x 70	75,0 x 50,0	11,0	42	160
21N GYP 150 P04	150	100	32	77 x 67	61,5 / 56,0 x 51,5 / 46,5	8,5	41	185



LENKROLLE MIT ANSCHRAUBPLATTE UND RICHTUNGSFESTSTELLER

BESTELLCODE	mm	kg	mm	mm	mm	mm	mm	mm
21I GYP 100 P04	100	100	32	77 x 67	61,5 / 56,0 x 51,5 / 46,5	8,5	44	135
21I GYP 125 P04	125	100	32	77 x 67	61,5 / 56,0 x 51,5 / 46,5	8,5	42	160
21I GYP 150 P04	150	100	32	77 x 67	61,5 / 56,0 x 51,5 / 46,5	8,5	41	185



BOCKROLLE MIT ANSCHRAUBPLATTE

BESTELLCODE	mm	kg	mm	mm	mm	mm	mm	mm
21B GYP 050 P02	50	50	19	55 x 55	44,0 / 38,5 x 44,0 / 38,5	6,3		70
21B GYP 075 P14	75	75	25	67 x 60	48,0 / 40,0 x 48,0 / 40,0	6,3		100
21B GYP 100 P04	100	100	32	77 x 67	61,5 / 56,0 x 51,5 / 46,5	8,5		135
21B GYP 125 P04	125	100	32	77 x 67	61,5 / 56,0 x 51,5 / 46,5	8,5		160
21B GYP 125 P05	125	100	32	95 x 70	75,0 x 50,0	11,0		160
21B GYP 150 P04	150	100	32	77 x 67	61,5 / 56,0 x 51,5 / 46,5	8,5		185



VARIANTEN: Auch mit Gleitlager GYO (elektrisch leitfähig, spurlos) lieferbar.

Bitte beachten Sie auch unsere Sicherheitshinweise zur Leitfähigkeit auf Seite 10.

GEHÄUSE

- Stahlblech verzinkt-chromatiert
- Schwenklager mit zweifachem Kugelkranz
- Radachse verschraubt

RAD GYP

- Radkörper aus Polypropylen
- Lauffläche aus thermoplastischem Gummi, elektrisch leitfähig
- Farbe grau, spurlos
- Fadenschutz
- Präzisionskugellager

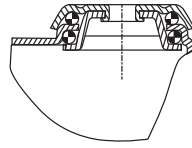

50 - 100 KG

- Durchmesser 50 - 150 mm
- Gehäuse aus Stahlblech
- Thermoplastisches Gummirad
- elektrisch leitfähig

**APPARATE
ROLLEN**

SERIE **21**



LENKROLLE MIT RÜCKENLOCH

BESTELLCODE	mm	kg	mm	mm	mm	mm
21L GYP 050 P01	50	50	19	11	25	70
21L GYP 075 P01	75	75	25	11	24	100
21L GYP 100 P01	100	100	32	11	37	135
21L GYP 125 P01	125	100	32	11	40	160
21L GYP 150 P01	150	100	32	11	44	185



LENKROLLE MIT RÜCKENLOCH UND TOTALFESTSTELLER

BESTELLCODE	mm	kg	mm	mm	mm	mm
21N GYP 050 P01	50	50	19	11	25	70
21N GYP 075 P01	75	75	25	11	24	100
21N GYP 100 P01	100	100	32	11	44	135
21N GYP 125 P01	125	100	32	11	42	160
21N GYP 150 P01	150	100	32	11	41	185



BOCKROLLE MIT RÜCKENLOCH

BESTELLCODE	mm	kg	mm	mm	mm
21B GYP 075 P01	75	75	25	11	100
21B GYP 100 P01	100	100	32	11	135
21B GYP 125 P01	125	100	32	11	160



RAD

BESTELLCODE	mm	kg	mm	mm	mm
GYP 050 x 19 - 6 - 22	50	50	19	6	22
GYP 075 x 25 - 6 - 28	75	75	25	6	28
GYP 100 x 32 - 8 - 36	100	100	32	8	36
GYP 125 x 32 - 8 - 36	125	100	32	8	36
GYP 150 x 32 - 8 - 36	150	100	32	8	36
GYP 200 x 32 - 8 - 36	200	100	32	8	36



VARIANTEN: Auch mit Befestigungsschraube (S01) lieferbar.
Bei Rad-Ø 100 - 150 mm auch mit Rückenloch-Ø 13 mm lieferbar.

Bitte beachten Sie auch unsere Sicherheitshinweise zur Leitfähigkeit auf Seite 10.



50 - 100 KG

- Durchmesser 50 - 150 mm
- Gehäuse aus Stahlblech
- Thermoplastisches Gummirad
- elektrisch leitfähig

SERIE 21

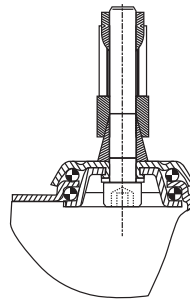

GEHÄUSE

- Stahlblech verzinkt-chromatiert
- Schwenklager mit zweifachem Kugelkranz
- Radachse verschraubt

RAD GYP

- Radkörper aus Polypropylen
- Lauffläche aus thermoplastischem Gummi, elektrisch leitfähig
- Farbe grau, spurlos
- Fadenschutz
- Präzisionskugellager

EXPANDERBEFESTIGUNG RUND



BESTELLCODE	Rohr-Innen- durchmesser in mm
Z06 - 18,0 - 20,0	18,0 - 20,0
Z06 - 19,0 - 21,5	19,0 - 21,5
Z06 - 21,5 - 24,0	21,5 - 24,0

BESTELLCODE	Rohr-Innen- durchmesser in mm
Z06 - 24,0 - 27,0	24,0 - 27,0
Z06 - 27,0 - 30,0	27,0 - 30,0
Z06 - 31,0 - 35,0	31,0 - 35,0

BITTE BEACHTEN: Bei Bestellungen bitte immer das **Rohr-Innenmaß** angeben!

LENKROLLE MIT EXPANDERBEFESTIGUNG RUND



BESTELLCODE	mm	kg	mm	mm	mm
21L GYP 050 Z06	50	50	19	25	73
21L GYP 075 Z06	75	75	25	24	103
21L GYP 100 Z06	100	100	32	37	138
21L GYP 125 Z06	125	100	32	40	163
21L GYP 150 Z06	150	100	32	44	188

LENKROLLE MIT EXPANDERBEFESTIGUNG RUND UND TOTALFESTSTELLER



BESTELLCODE	mm	kg	mm	mm	mm
21N GYP 050 Z06	50	50	19	25	73
21N GYP 075 Z06	75	75	25	24	103
21N GYP 100 Z06	100	100	32	44	138
21N GYP 125 Z06	125	100	32	42	163
21N GYP 150 Z06	150	100	32	41	188

Bitte beachten Sie auch unsere Sicherheitshinweise zur Leitfähigkeit auf Seite 10.

GEHÄUSE

- Stahlblech verzinkt-chromatiert
- Schwenklager mit zweifachem Kugelkranz
- Radachse verschraubt

RAD GYP

- Radkörper aus Polypropylen
- Lauffläche aus thermoplastischem Gummi, elektrisch leitfähig
- Farbe grau, spurlos
- Fadenschutz
- Präzisionskugellager

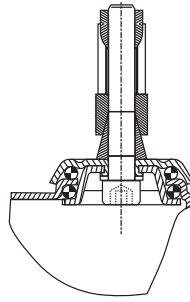

50 - 100 KG

- Durchmesser 50 - 150 mm
- Gehäuse aus Stahlblech
- Thermoplastisches Gummirad
- elektrisch leitfähig

**APPARATE
ROLLEN**

SERIE **21**



EXPANDERBEFESTIGUNG VIERKANT







BESTELLCODE	Rohr-Innen- durchmesser in mm
Z07 - 18,0 - 20,0	18,0 - 20,0
Z07 - 21,5 - 24,0	21,5 - 24,0
Z07 - 24,0 - 27,0	24,0 - 27,0

BESTELLCODE	Rohr-Innen- durchmesser in mm
Z07 - 27,0 - 30,0	27,0 - 30,0
Z07 - 32,0 - 35,0	32,0 - 35,0
Z07 - 36,0 - 40,0	36,0 - 40,0

BITTE BEACHTEN: Bei Bestellungen bitte immer das **Rohr-Innenmaß** angeben!





LENKROLLE MIT EXPANDERBEFESTIGUNG VIERKANT



BESTELLCODE	 mm	 kg	 mm	 mm	 mm
21L GYP 050 Z07	50	50	19	25	73
21L GYP 075 Z07	75	75	25	24	103
21L GYP 100 Z07	100	100	32	37	138
21L GYP 125 Z07	125	100	32	40	163
21L GYP 150 Z07	150	100	32	44	188

LENKROLLE MIT EXPANDERBEFESTIGUNG VIERKANT UND TOTALFESTSTELLER



BESTELLCODE	 mm	 kg	 mm	 mm	 mm
21N GYP 050 Z07	50	50	19	25	73
21N GYP 075 Z07	75	75	25	24	103
21N GYP 100 Z07	100	100	32	44	138
21N GYP 125 Z07	125	100	32	42	163
21N GYP 150 Z07	150	100	32	41	188

Bitte beachten Sie auch unsere Sicherheitshinweise zur Leitfähigkeit auf Seite 10.



50 - 100 KG

SERIE 21

- Durchmesser 50 - 150 mm
- Gehäuse aus Stahlblech
- Polyurethanrad

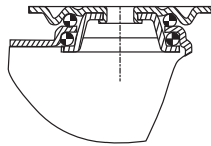

GEHÄUSE

- Stahlblech verzinkt-chromatiert
- Schwenklager mit zweifachem Kugelkranz
- Radachse verschraubt

RAD AUP

- Radkörper aus Polyamid
- Lauffläche aus Polyurethan
- Fadenschutz
- Präzisionskugellager



LENKROLLE MIT ANSCHRAUBPLATTE

BESTELLCODE	mm	kg	mm	mm	mm	mm	mm	mm
21L AUP 050 P03	50	50	19	60 x 60	48,0 / 38,0 x 48,0 / 38,0	6,3	25	70
21L AUP 075 P03	75	75	25	60 x 60	48,0 / 38,0 x 48,0 / 38,0	6,3	24	100
21L AUP 100 P04	100	100	32	77 x 67	61,5 / 56,0 x 51,5 / 46,5	8,5	37	135
21L AUP 125 P04	125	100	32	77 x 67	61,5 / 56,0 x 51,5 / 46,5	8,5	40	160
21L AUP 125 P05	125	100	32	95 x 70	75,0 x 50,0	11,0	40	160
21L AUP 150 P04	150	100	32	77 x 67	61,5 / 56,0 x 51,5 / 46,5	8,5	44	185



LENKROLLE MIT ANSCHRAUBPLATTE UND TOTALFESTSTELLER

BESTELLCODE	mm	kg	mm	mm	mm	mm	mm	mm
21N AUP 050 P03	50	50	19	60 x 60	48,0 / 38,0 x 48,0 / 38,0	6,3	25	70
21N AUP 075 P03	75	75	25	60 x 60	48,0 / 38,0 x 48,0 / 38,0	6,3	24	100
21N AUP 100 P04	100	100	32	77 x 67	61,5 / 56,0 x 51,5 / 46,5	8,5	44	135
21N AUP 125 P04	125	100	32	77 x 67	61,5 / 56,0 x 51,5 / 46,5	8,5	42	160
21N AUP 125 P05	125	100	32	95 x 70	75,0 x 50,0	11,0	42	160
21N AUP 150 P04	150	100	32	77 x 67	61,5 / 56,0 x 51,5 / 46,5	8,5	41	185



LENKROLLE MIT ANSCHRAUBPLATTE UND RICHTUNGSFESTSTELLER

BESTELLCODE	mm	kg	mm	mm	mm	mm	mm	mm
21I AUP 100 P04	100	100	32	77 x 67	61,5 / 56,0 x 51,5 / 46,5	8,5	44	135
21I AUP 125 P04	125	100	32	77 x 67	61,5 / 56,0 x 51,5 / 46,5	8,5	42	160
21I AUP 150 P04	150	100	32	77 x 67	61,5 / 56,0 x 51,5 / 46,5	8,5	41	185



BOCKROLLE MIT ANSCHRAUBPLATTE

BESTELLCODE	mm	kg	mm	mm	mm	mm	mm	mm
21B AUP 050 P02	50	50	19	55 x 55	44,0 / 38,5 x 44,0 / 38,5	6,3		70
21B AUP 075 P14	75	75	25	67 x 60	48,0 / 40,0 x 48,0 / 40,0	6,3		100
21B AUP 100 P04	100	100	32	77 x 67	61,5 / 56,0 x 51,5 / 46,5	8,5		135
21B AUP 125 P04	125	100	32	77 x 67	61,5 / 56,0 x 51,5 / 46,5	8,5		160
21B AUP 125 P05	125	100	32	95 x 70	75,0 x 50,0	11,0		160
21B AUP 150 P04	150	100	32	77 x 67	61,5 / 56,0 x 51,5 / 46,5	8,5		185

GEHÄUSE

- Stahlblech verzinkt-chromatiert
- Schwenklager mit zweifachem Kugelkranz
- Radachse verschraubt

RAD AUP

- Radkörper aus Polyamid
- Lauffläche aus Polyurethan
- Fadenschutz
- Präzisionskugellager

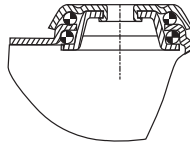

50 - 100 KG







- Durchmesser 50 - 150 mm
- Gehäuse aus Stahlblech
- Polyurethanrad

**APPARATE
ROLLEN**

SERIE **21**









LENKROLLE MIT RÜCKENLOCH





BESTELLCODE	 mm	 kg	 mm	 mm	 mm	 mm
21L AUP 050 P01	50	50	19	11	25	70
21L AUP 075 P01	75	75	25	11	24	100
21L AUP 100 P01	100	100	32	11	37	135
21L AUP 125 P01	125	100	32	11	40	160
21L AUP 150 P01	150	100	32	11	44	185



LENKROLLE MIT RÜCKENLOCH UND TOTALFESTSTELLER

BESTELLCODE	 mm	 kg	 mm	 mm	 mm	 mm
21N AUP 050 P01	50	50	19	11	25	70
21N AUP 075 P01	75	75	25	11	24	100
21N AUP 100 P01	100	100	32	11	44	135
21N AUP 125 P01	125	100	32	11	42	160
21N AUP 150 P01	150	100	32	11	41	185

RAD

BESTELLCODE	 mm	 kg	 mm	 mm	 mm
AUP 050 x 19 - 6 - 22	50	50	19	6	22
AUP 075 x 25 - 6 - 28	75	75	25	6	28
AUP 100 x 32 - 8 - 36	100	150	32	8	36
AUP 125 x 32 - 8 - 36	125	150	32	8	36
AUP 150 x 32 - 8 - 36	150	150	32	8	36



 **VARIANTEN:** Teilweise auch mit Rad SXP (elektrisch leitfähig, spurlos) lieferbar.



50 - 100 KG

- Durchmesser 50 - 125 mm
- Gehäuse aus Stahlblech
- Polyamidrad - Polypropylenrad

SERIE **21**

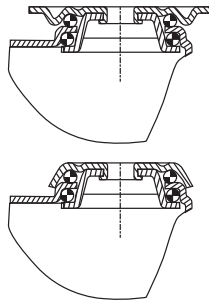

GEHÄUSE

- Stahlblech verzinkt-chromatiert
- Schwenklager mit zweifachem Kugelkranz
- Radachse verschraubt

RAD OUO

- Rad aus Polyamid
- Gleitlager

RAD OPO

- Rad aus Polypropylen
- Gleitlager



LENKROLLE MIT ANSCHRAUBPLATTE

BESTELLCODE	mm	kg	mm	mm	mm	mm	mm
21L OUO 050 P03	50	50	19	60 x 60	48,0 / 38,0 x 48,0 / 38,0	6,3	70
21L OUO 075 P03	75	75	23	60 x 60	48,0 / 38,0 x 48,0 / 38,0	6,3	100
21L OPO 100 P04	100	80	32	77 x 67	61,5 / 56,0 x 51,5 / 46,5	8,5	135
21L OPO 125 P04	125	100	32	77 x 67	61,5 / 56,0 x 51,5 / 46,5	8,5	160



LENKROLLE MIT ANSCHRAUBPLATTE UND TOTALFESTSTELLER

BESTELLCODE	mm	kg	mm	mm	mm	mm	mm
21N OUO 050 P03	50	50	19	60 x 60	48,0 / 38,0 x 48,0 / 38,0	6,3	70
21N OUO 075 P03	75	75	23	60 x 60	48,0 / 38,0 x 48,0 / 38,0	6,3	100
21N OPO 100 P04	100	80	32	77 x 67	61,5 / 56,0 x 51,5 / 46,5	8,5	135
21N OPO 125 P04	125	100	32	77 x 67	61,5 / 56,0 x 51,5 / 46,5	8,5	160



LENKROLLE MIT RÜCKENLOCH

BESTELLCODE	mm	kg	mm	mm	mm	mm
21L OUO 050 P01	50	50	19	11	25	70
21L OUO 075 P01	75	75	23	11	24	100
21L OPO 100 P01	100	80	32	11	37	135
21L OPO 125 P01	125	100	32	11	40	160



LENKROLLE MIT RÜCKENLOCH UND TOTALFESTSTELLER

BESTELLCODE	mm	kg	mm	mm	mm	mm
21N OUO 050 P01	50	50	19	11	25	70
21N OUO 075 P01	75	75	23	11	24	100
21N OPO 100 P01	100	80	32	11	44	135
21N OPO 125 P01	125	100	32	11	42	160

GEHÄUSE

- Stahlblech verzinkt-chromatiert
- Schwenklager mit zweifachem Kugelkranz
- Radachse verschraubt

RAD ODO

- Rad aus Polyamid
- Gleitlager

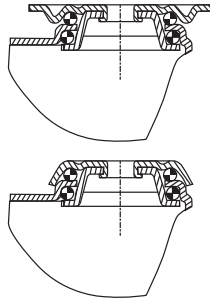

70 - 100 KG









- Durchmesser 50 - 75 mm
- Gehäuse aus Stahlblech
- Polyamidrad

**APPARATE
ROLLEN**

SERIE **24**











DOPPEL-LENKROLLE MIT ANSCHRAUBPLATTE

BESTELLCODE	 mm	 kg	 mm	 mm	 mm	 mm	 mm	 mm
24L ODO 050 P03	50	70	2 x 19	60 x 60	48,0 / 38,0 x 48,0 / 38,0	6,3	25	73
24L ODO 075 P04	75	100	2 x 23	77 x 67	61,5 / 56,0 x 51,5 / 46,5	8,5	32	102









DOPPEL-LENKROLLE MIT ANSCHRAUBPLATTE UND TOTALFESTSTELLER

BESTELLCODE	 mm	 kg	 mm	 mm	 mm	 mm	 mm	 mm
24N ODO 050 P03	50	70	2 x 19	60 x 60	48,0 / 38,0 x 48,0 / 38,0	6,3	25	73
24N ODO 075 P04	75	100	2 x 23	77 x 67	61,5 / 56,0 x 51,5 / 46,5	8,5	32	102









DOPPEL-LENKROLLE MIT RÜCKENLOCH

BESTELLCODE	 mm	 kg	 mm	 mm	 mm	 mm
24L ODO 050 P01	50	70	2 x 19	11	25	70
24L ODO 075 P01	75	100	2 x 23	11	32	99



DOPPEL-LENKROLLE MIT RÜCKENLOCH UND TOTALFESTSTELLER

BESTELLCODE	 mm	 kg	 mm	 mm	 mm	 mm
24N ODO 050 P01	50	70	2 x 19	11	25	70
24N ODO 075 P01	75	100	2 x 23	11	32	99



70 - 100 KG

- Durchmesser 50 - 75 mm
- Gehäuse aus Stahlblech
- Thermoplastisches Gummirad

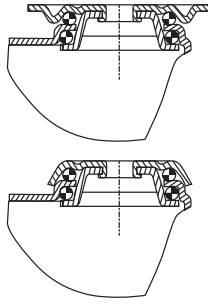

GEHÄUSE

- Stahlblech verzinkt-chromatiert
- Schwenklager mit zweifachem Kugelkranz
- Radachse verschraubt

RAD JPO

- Radkörper aus Polypropylen
- Lauffläche aus thermo-
plastischem Gummi
- Farbe grau, spurlos
- Gleitlager

SERIE **24**



DOPPEL-LENKROLLE MIT ANSCHRAUBPLATTE

BESTELLCODE	mm	kg	mm	mm	mm	mm	mm	mm
24L JPO 050 P03	50	70	2 x 19	60 x 60	48,0 / 38,0 x 48,0 / 38,0	6,3	25	73
24L JPO 075 P04	75	100	2 x 25	77 x 67	61,5 / 56,0 x 51,5 / 46,5	8,5	32	102



DOPPEL-LENKROLLE MIT ANSCHRAUBPLATTE UND TOTALFESTSTELLER

BESTELLCODE	mm	kg	mm	mm	mm	mm	mm	mm
24N JPO 050 P03	50	70	2 x 19	60 x 60	48,0 / 38,0 x 48,0 / 38,0	6,3	25	73
24N JPO 075 P04	75	100	2 x 25	77 x 67	61,5 / 56,0 x 51,5 / 46,5	8,5	32	102



DOPPEL-LENKROLLE MIT RÜCKENLOCH

BESTELLCODE	mm	kg	mm	mm	mm	mm
24L JPO 050 P01	50	70	2 x 19	11	25	70
24L JPO 075 P01	75	100	2 x 25	11	32	99



DOPPEL-LENKROLLE MIT RÜCKENLOCH UND TOTALFESTSTELLER

BESTELLCODE	mm	kg	mm	mm	mm	mm
24N JPO 050 P01	50	70	2 x 19	11	25	70
24N JPO 075 P01	75	100	2 x 25	11	32	99

GEHÄUSE

- Stahlblech verzinkt-chromatiert
- Schwenklager mit zweifachem Kugelkranz
- Radachse verschraubt

RAD JPP

- Radkörper aus Polypropylen
- Lauffläche aus thermo-plastischem Gummi
- Farbe grau, spurlos
- Fadenschutz
- Präzisionskugellager

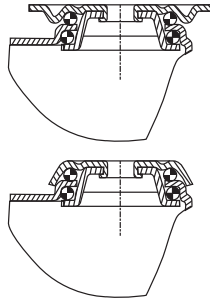

70 - 100 KG









- Durchmesser 50 - 75 mm
- Gehäuse aus Stahlblech
- Thermoplastisches Gummirad

**APPARATE
ROLLEN**

SERIE **24**











DOPPEL-LENKROLLE MIT ANSCHRAUBPLATTE

BESTELLCODE	 mm	 kg	 mm	 mm	 mm	 mm	 mm	 mm
24L JPP 050 P03	50	70	2 x 19	60 x 60	48,0 / 38,0 x 48,0 / 38,0	6,3	25	73
24L JPP 075 P04	75	100	2 x 25	77 x 67	61,5 / 56,0 x 51,5 / 46,5	8,5	32	102









DOPPEL-LENKROLLE MIT ANSCHRAUBPLATTE UND TOTALFESTSTELLER

BESTELLCODE	 mm	 kg	 mm	 mm	 mm	 mm	 mm	 mm
24N JPP 050 P03	50	70	2 x 19	60 x 60	48,0 / 38,0 x 48,0 / 38,0	6,3	25	73
24N JPP 075 P04	75	100	2 x 25	77 x 67	61,5 / 56,0 x 51,5 / 46,5	8,5	32	102



DOPPEL-LENKROLLE MIT RÜCKENLOCH

BESTELLCODE	 mm	 kg	 mm	 mm	 mm	 mm
24L JPP 050 P01	50	70	2 x 19	11	25	70
24L JPP 075 P01	75	100	2 x 25	11	32	99



DOPPEL-LENKROLLE MIT RÜCKENLOCH UND TOTALFESTSTELLER

BESTELLCODE	 mm	 kg	 mm	 mm	 mm	 mm
24N JPP 050 P01	50	70	2 x 19	11	25	70
24N JPP 075 P01	75	100	2 x 25	11	32	99



70 KG

SERIE 14

- Durchmesser 75 mm
- Gehäuse aus Polyamid
- Thermoplastisches Gummirad

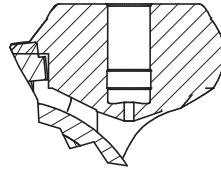

GEHÄUSE

- Polyamid
- Sackloch
- Radachse verschraubt

RAD JPO

- Radkörper aus Polypropylen
- Lauffläche aus thermoplastischem Gummi
- Farbe grau, spurlos
- Gleitlager



KUNSTSTOFF-LENKROLLE MIT BUNDSTIFT-ANSCHRAUBPLATTE

BESTELLCODE	mm	kg	mm	mm	mm	mm	mm	mm
14L JPO 075 B02-60x60	75	70	25	60 x 60	48 / 38 x 48 / 38	6,3	32	110



KUNSTSTOFF-LENKROLLE MIT BUNDSTIFT-ANSCHRAUBPLATTE UND RADFESTSTELLER

BESTELLCODE	mm	kg	mm	mm	mm	mm	mm	mm
14R JPO 075 B02-60x60	75	70	25	60 x 60	48 / 38 x 48 / 38	6,3	32	110



KUNSTSTOFF-LENKROLLE MIT GEWINDESTIFT M 10 X 20

BESTELLCODE	mm	kg	mm	mm	mm	mm
14L JPO 075 B09-M10x20	75	70	25	10	32	105



KUNSTSTOFF-LENKROLLE MIT GEWINDESTIFT M 10 X 20 UND RADFESTSTELLER

BESTELLCODE	mm	kg	mm	mm	mm	mm
14R JPO 075 B09-M10x20	75	70	25	10	32	105

VARIANTEN: Auch mit Rad GYO (elektrisch leitfähig, spurlos) lieferbar.

GEHÄUSE

- Polyamid
- Sackloch
- Radachse verschraubt

RAD JPP

- Radkörper aus Polypropylen
- Lauffläche aus thermoplastischem Gummi
- Farbe grau, spurlos
- Fadenschutz
- Präzisionskugellager

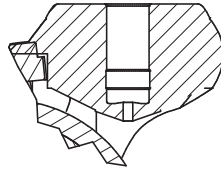

70 KG

- Durchmesser 75 mm
- Gehäuse aus Polyamid
- Thermoplastisches Gummirad

**APPARATE
ROLLEN**

SERIE **14**



KUNSTSTOFF-LENKROLLE MIT BUNDSTIFT-ANSCHRAUBPLATTE

BESTELLCODE	mm	kg	mm	mm	mm	mm	mm	mm
14L JPP 075 B02-60x60	75	70	25	60 x 60	48 / 38 x 48 / 38	6,3	32	110



KUNSTSTOFF-LENKROLLE MIT BUNDSTIFT-ANSCHRAUBPLATTE UND RADFESTSTELLER

BESTELLCODE	mm	kg	mm	mm	mm	mm	mm	mm
14R JPP 075 B02-60x60	75	70	25	60 x 60	48 / 38 x 48 / 38	6,3	32	110



KUNSTSTOFF-LENKROLLE MIT GEWINDESTIFT M 10 X 20

BESTELLCODE	mm	kg	mm	mm	mm	mm
14L JPP 075 B09-M10x20	75	70	25	10		105



KUNSTSTOFF-LENKROLLE MIT GEWINDESTIFT M 10 X 20 UND RADFESTSTELLER

BESTELLCODE	mm	kg	mm	mm	mm	mm
14R JPP 075 B09-M10x20	75	70	25	10		105

VARIANTEN: Auch mit Rad GYP (elektrisch leitfähig, spurlos) lieferbar.



100 KG

SERIE 05

- Durchmesser 75 - 125 mm
- Gehäuse aus Polyamid
- Thermoplastisches Gummirad

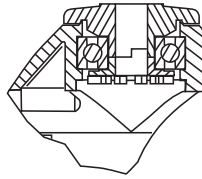

GEHÄUSE

- Glasfaserverstärktes Polyamid
- Präzisionskugellager als Kopflager
- Radachse verschraubt

RAD JPO

- Radkörper aus Polypropylen
- Lauffläche aus thermoplastischem Gummi
- Farbe grau, spurlos
- Gleitlager



KUNSTSTOFF-LENKROLLE MIT ANSCHRAUBPLATTE

BESTELLCODE	mm	kg	mm	mm	mm	mm	mm	mm
05L JPO 075 P04	75	100	30	77 x 67	61,5 / 56,0 x 51,5 / 46,5	8,5	41	114
05L JPO 100 P04	100	100	32	77 x 67	61,5 / 56,0 x 51,5 / 46,5	8,5	43	140
05L JPO 100 P05	100	100	32	95 x 70	75,0 x 50,0	11,0	43	140
05L JPO 125 P04	125	100	32	77 x 67	61,5 / 56,0 x 51,5 / 46,5	8,5	46	169
05L JPO 125 P05	125	100	32	95 x 70	75,0 x 50,0	11,0	46	169



KUNSTSTOFF-LENKROLLE MIT ANSCHRAUBPLATTE UND TOTALFESTSTELLER

BESTELLCODE	mm	kg	mm	mm	mm	mm	mm	mm
05N JPO 075 P04	75	100	30	77 x 67	61,5 / 56,0 x 51,5 / 46,5	8,5	41	114
05N JPO 100 P04	100	100	32	77 x 67	61,5 / 56,0 x 51,5 / 46,5	8,5	43	140
05N JPO 100 P05	100	100	32	95 x 70	75,0 x 50,0	11,0	43	140
05N JPO 125 P04	125	100	32	77 x 67	61,5 / 56,0 x 51,5 / 46,5	8,5	46	169
05N JPO 125 P05	125	100	32	95 x 70	75,0 x 50,0	11,0	46	169



KUNSTSTOFF-LENKROLLE MIT RÜCKENLOCH

BESTELLCODE	mm	kg	mm	mm	mm	mm
05L JPO 075 P01	75	100	30	10,2	41	106
05L JPO 100 P01	100	100	32	10,2	43	135
05L JPO 125 P01	125	100	32	10,2	46	161



KUNSTSTOFF-LENKROLLE MIT RÜCKENLOCH UND TOTALFESTSTELLER

BESTELLCODE	mm	kg	mm	mm	mm	mm
05N JPO 075 P01	75	100	30	10,2	41	106
05N JPO 100 P01	100	100	32	10,2	43	135
05N JPO 125 P01	125	100	32	10,2	46	161



Version 75 mm nur mit dieser abgerundeten Tritthebelversion lieferbar.

VARIANTEN: Lieferbar mit Zapfen Z01, Expanderbefestigung Z06 (Rundrohr) und Z07 (Vierkantrohr) oder Schrauben S01 sowie in schwarz. Alle Größen auch elektrisch leitfähig lieferbar.



GEHÄUSE

- Glasfaserverstärktes Polyamid
- Präzisionskugellager als Kopflager
- Radachse verschraubt

RAD JPP

- Radkörper aus Polypropylen
- Lauffläche aus thermoplastischem Gummi
- Farbe grau, spurlos
- Fadenschutz
- Präzisionskugellager

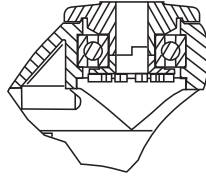

100 KG

- Durchmesser 75 - 125 mm
- Gehäuse aus Polyamid
- Thermoplastisches Gummirad

**APPARATE
ROLLEN**

SERIE **05**



KUNSTSTOFF-LENKROLLE MIT ANSCHRAUBPLATTE

BESTELLCODE	mm	kg	mm	mm	mm	mm	mm	mm
05L JPP 075 P04	75	100	30	77 x 67	61,5 / 56,0 x 51,5 / 46,5	8,5	41	114
05L JPP 100 P04	100	100	32	77 x 67	61,5 / 56,0 x 51,5 / 46,5	8,5	43	140
05L JPP 100 P05	100	100	32	95 x 70	75,0 x 50,0	11,0	43	140
05L JPP 125 P04	125	100	32	77 x 67	61,5 / 56,0 x 51,5 / 46,5	8,5	46	169
05L JPP 125 P05	125	100	32	95 x 70	75,0 x 50,0	11,0	46	169



KUNSTSTOFF-LENKROLLE MIT ANSCHRAUBPLATTE UND TOTALFESTSTELLER

BESTELLCODE	mm	kg	mm	mm	mm	mm	mm	mm
05N JPP 075 P04	75	100	30	77 x 67	61,5 / 56,0 x 51,5 / 46,5	8,5	41	114
05N JPP 100 P04	100	100	32	77 x 67	61,5 / 56,0 x 51,5 / 46,5	8,5	43	140
05N JPP 100 P05	100	100	32	95 x 70	75,0 x 50,0	11,0	43	140
05N JPP 125 P04	125	100	32	77 x 67	61,5 / 56,0 x 51,5 / 46,5	8,5	46	169
05N JPP 125 P05	125	100	32	95 x 70	75,0 x 50,0	11,0	46	169



KUNSTSTOFF-LENKROLLE MIT RÜCKENLOCH

BESTELLCODE	mm	kg	mm	mm	mm	mm	
05L JPP 075 P01	75	100	30		10,2	41	106
05L JPP 100 P01	100	100	32		10,2	43	135
05L JPP 125 P01	125	100	32		10,2	46	161



KUNSTSTOFF-LENKROLLE MIT RÜCKENLOCH UND TOTALFESTSTELLER

BESTELLCODE	mm	kg	mm	mm	mm	mm	
05N JPP 075 P01	75	100	30		10,2	41	106
05N JPP 100 P01	100	100	32		10,2	43	135
05N JPP 125 P01	125	100	32		10,2	46	161



Version 75 mm nur mit dieser abgerundeten Tritthebelversion lieferbar.

VARIANTEN: Lieferbar mit Zapfen Z01, Expanderbefestigung Z06 (Rundrohr) und Z07 (Vierkantrohr) oder Schrauben S01 sowie in schwarz.
 Alle Größen auch elektrisch leitfähig lieferbar.

